

















# N4 G

## Datenblatt



Abbildung: N4 G | Naturstein: Blanco Carrara

Standard	Gesamtgewicht	Optional	Zubehör	Naturstein	Gas-Kamineinsatz
 <p>Stahlblech anthrazit (matt)</p>	 <p>ca. 483 kg</p>	 <p>Glaskeramik schwarz (glänzend)</p>	 <p>LED-Ambiente Beleuchtung</p>	<div style="display: flex; flex-wrap: wrap;"> <div style="width: 50%;">  <p><i>Blanco Carrara</i></p> </div> <div style="width: 50%;">  <p><i>Blanco Macael</i></p> </div> <div style="width: 50%;">  <p><i>Blanco Nacarado</i></p> </div> <div style="width: 50%;">  <p><i>Caliza Moka</i></p> </div> <div style="width: 50%;">  <p><i>Crema Marfil</i></p> </div> <div style="width: 50%;">  <p><i>Marron Emperador</i></p> </div> <div style="width: 50%;">  <p><i>Travertino Romano</i></p> </div> <div style="width: 50%;">  <p><i>Negro Abanilla</i></p> </div> <div style="width: 50%;">  <p><i>Rojo Alicante</i></p> </div> <div style="width: 50%;">  <p><i>Rosa Claro</i></p> </div> <div style="width: 50%;">  <p><i>Rosa Crema</i></p> </div> </div> <p>Weitere Natursteinausführungen auf Anfrage erhältlich.</p>	 <p>Lina G 87 Leistungsbereich: <math>I_{2E} / I_{2H}</math>: 2,8 – 8,1 kW <math>I_{2ELL}</math>: 2,8 – 8,1 kW <math>I_{3B/P50}</math>: 2,3 – 7,3 kW</p> <p>Abgasanschluss: Ø 130 / 200 mm</p> <div style="text-align: center;">  <p><b>A</b></p> </div> <p>Energieeffizienzklasse nach (EU) 2015/1186 für Gas-Kamineinsatz</p> <p>Mehr Infos unter <a href="http://www.camina-schmid.de">www.camina-schmid.de</a></p>

# N4 G

## Maßzeichnung

Frontansicht M 1:25

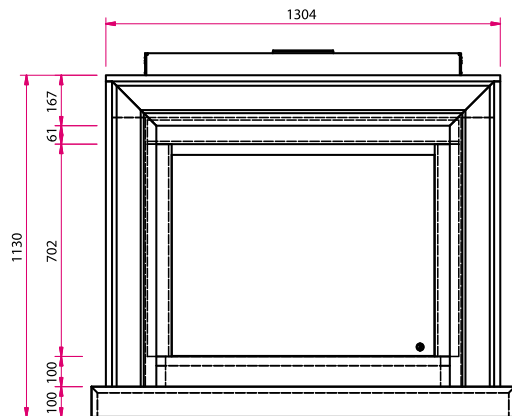

Seitenansicht M 1:25

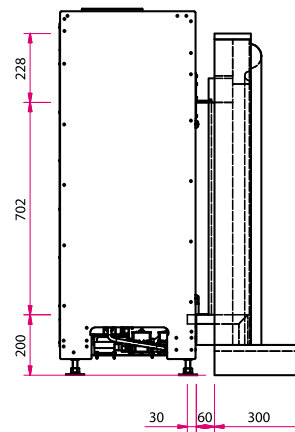

Draufsicht M 1:25

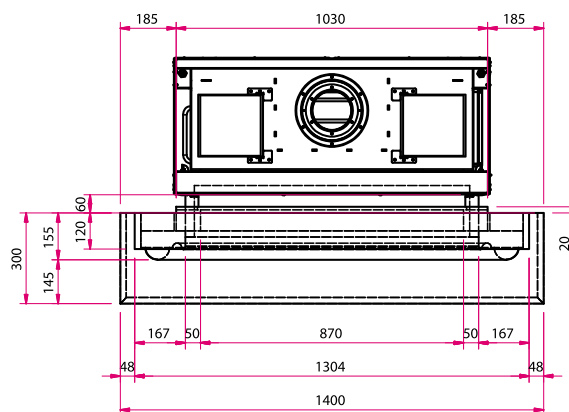

Bitte beachten Sie die Angaben für **optionales Zubehör** in unserer Preisliste.

Abbildungen ähnlich. Alle Abbildungen und Zeichnungen sind urheberrechtlich geschützt. Verwertung oder Veröffentlichung, auch einzelner Details, nur mit unserer Genehmigung. Farbliche und technische Änderungen durch Weiterentwicklungen sowie Irrtümer vorbehalten. Stand: 06/2021